

BASO 1.5

DIRECT / INDIRECT



Catalog Number Example

BASO 1.5-PDT-BL-OPBW-30K-C80-UNV-010V-SEN-0400LF-DC-ST-48IN

A RANGE

BASO 1.5 BASO 1.5

B MOUNTING

QS Pendant P D T

Pendant in-line ACT T-BAR P A T

Pendant in-line ACT SLOT P A S

Pendant ACT center tile P A C

pendant suspension set includes cable suspension and one white power feeder with a white junction box cover

Wall mounted W A L

for black power feeds or junction box covers, please contact customer service

C COLOR

QS White W H

QS Black B L

Gray G R

Custom color RAL X X

trimless version available in white only

D LENS

HP opal cover direct O P B W

Batwing cover indirect

E CCT

2700K 2 7 K

QS 3000K 3 0 K

QS 3500K 3 5 K

4000K 4 0 K

F CRI

CRI > 80 C 8 0

CRI > 90 C 9 0

G VOLTAGE

120V / 277V U N V

H DIMMING

QS 0-10V 1% 0 1 0 V

Lutron EcoSystem L E S 1

Quantum, Vive, GRAFIK Eye, HomeWorks

Power over ethernet P O E C

consult customer service for compatibility

Custom dimming X X X X

consult customer service for compatibility

I SENSOR (optional)

Integrated Sensor S E N

consult customer service for sensor request

J OUTPUT LM/FT DOWN

QS 400 lm/ft ↓ 0 4 0 0 L F

QS 600 lm/ft ↓ 0 6 0 0 L F

800 lm/ft ↓ 0 8 0 0 L F

Custom lm/ft X X X X L F

custom lumen up to 800 lm/ft

K OUTPUT LM/FT UP

QS 400 lm/ft ↑ 0 4 0 0 L F

QS 600 lm/ft ↑ 0 6 0 0 L F

QS 800 lm/ft ↑ 0 8 0 0 L F

Custom lm/ft X X X X L F

custom lumen up to 1000 lm/ft

L CIRCUIT / EM

QS Single circuit *

EMC night light circuit N L C

EMB available in 4ft and 8ft E M #

Dual Circuit D C

* leave blank

M SHAPE / PATTERN

QS Linear / straight S T

Linear / straight + flex inset S F

includes 4ft. field-cutttable section

L-shape L S

□-shape (rectangular shape) R S

U-shape U S

Custom shape X X

N DIMENSIONS IN INCH

QS Linear 4' 4 8 I N

QS Linear 6' 7 2 I N

QS Linear 8' 9 6 I N

Linear custom # # # I N

Linear flex inset # # # I N

includes 4' to 3' field-cutttable section

L-Shape # # # X # # # I N

U-Shape # # # X # # # X # # # I N

□-Shape # # # X # # # I N

for lengths including flex insets, round up to the nearest total foot length

O CERTIFICATION (optional)

Red List Approved R L A

PERFORMANCE

- Up to 110lm/W efficiency
- 400 / 550lm/ft
- CRI > 80 & CRI > 90
- Damp rated

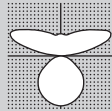

MOUNTING

Pendant

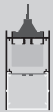

PATTERNS



*X Shapes



Angles



*Wall to Ceiling



Rectangles



*T Shapes

For customization, please contact customer service

FIELD-CUTTABLE FLEX

Down to 1/16"



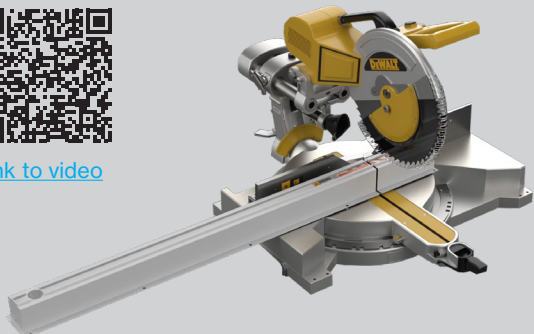

[link to video](#)



BASO
basolighting.com
xalusa.com

Technical data

	SIZE TYPE	LED COLOR TEMPERATURE	INPUT WATTS	DELIVERED LM TOTAL	LIGHT DISTRIBUTION	DELIVERED LM DIRECT	DELIVERED LM INDIRECT	OPTICAL EFFICIENCY	LUMINAIRE EFFICACY	
BASO DIRECT / INDIRECT										
	e LED	4' linear	40K	15.2W	1650lm	40% down / 60% up	157 lm/ft	253 lm/ft	70%	108 lm/W
		8' linear		30.5W	3300lm					
		2' + 2' corner		15.2W	1650lm					
	e ² LED	4' linear	40K	20.2W	2230lm	40% down / 60% up	215 lm/ft	343 lm/ft	70%	110 lm/W
		8' linear	30K, 35K	40.4W	4470lm					
		2' + 2' corner	40K	20.2W	2230lm					

for 30K or 35K multiply lm value by 0.96

Patterns top view

LINEAR

A	FIXTURES	CODE
48"	1 × 4' linear	ST - 0 4 FT
96"	1 × 8' linear	ST - 0 8 FT
144"	3 × 4' linear	ST - 1 2 FT



L-SHAPE

A / B	FIXTURES	CODE
48" / 48"	2 × 2' linear + 1 × 2' × 2' corner	LS - 0 4 X 0 4 FT
48" / 96"	1 × 2' linear + 1 × 6' linear + 1 × 2' × 2' corner	LS - 0 4 X 0 8 FT
96" / 96"	2 × 6' linear + 1 × 2' × 2' corner	LS - 0 8 X 0 8 FT

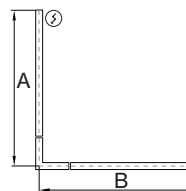

□-SHAPE (rectangular shape)

A / B	FIXTURES	CODE
48" / 48"	4 × 2' × 2' corner	RS - 0 4 X 0 4 FT
48" / 96"	2 × 4' linear + 4 × 2' × 2' corner	RS - 0 4 X 0 8 FT
96" / 96"	4 × 4' linear + 4 × 2' × 2' corner	RS - 0 8 X 0 8 FT

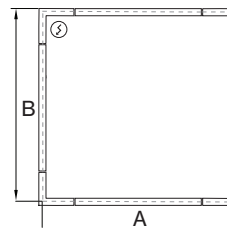

U-SHAPE

A / B / C	FIXTURES	CODE
48" / 48" / 48"	2 × 2' linear + 2 × 2' × 2' corner	US - 0 4 X 0 4 X 0 4 FT
48" / 96" / 48"	1 × 4' linear + 2 × 2' linear + 2 × 2' × 2' corner	US - 0 4 X 0 8 X 0 4 FT
48" / 144" / 48"	1 × 8' linear + 2 × 2' linear + 2 × 2' × 2' corner	US - 0 4 X 1 2 X 0 4 FT

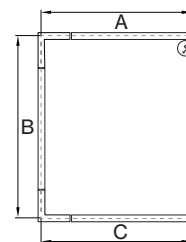

DIMENSIONS

BASO 1.5

PENDANT
direct

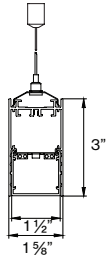

direct / indirect

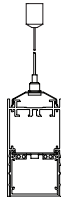

linear 4ft / 8ft

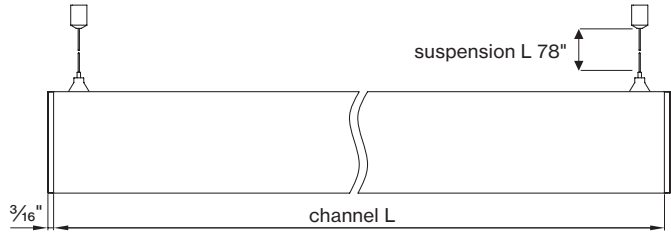

BASO 1.5 SPECIALITY MOUNTING

SURFACE
in-line ACT TBAR

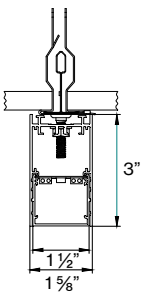

SURFACE
in-line ACT SLOT

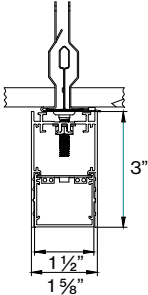

SURFACE
ACT center tile

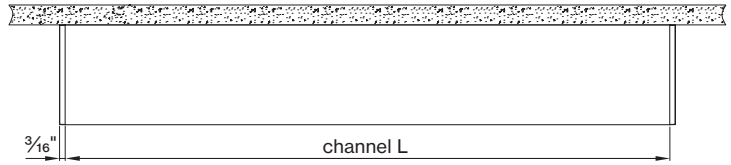
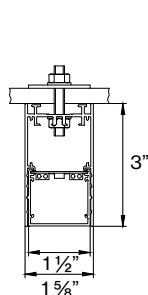

PENDANT
ACT TBAR

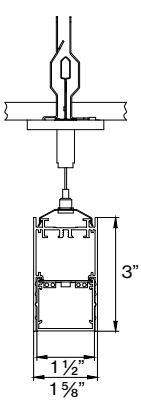

PENDANT
in-line ACT SLOT

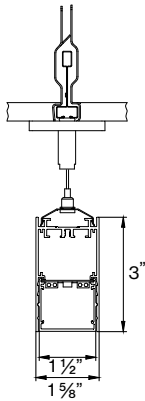

PENDANT
ACT center tile

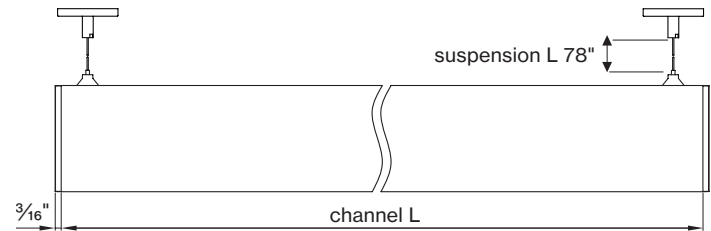
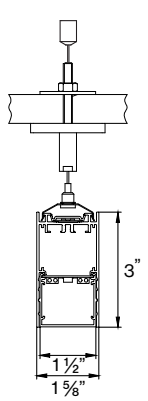

Declare.

BASO 1.5 2.5 4.0
XAL USA Incorporated

Final Assembly: Collins, Connecticut, USA
LIFE Expectancy: 30 Years
End of Life Options: Recyclable (70%), Landfill (30%)

Ingredients:
Aluminum, 2-Phenylacetic acid, 2-methyl-, methyl ester, polymer with ethyl 2-cyanobenzoate, Steel, manufacture, Chemicals, Copper Chloride (CuCl₂), Polyvinyl Chloride (PVC), Polyethylene Glycol (PEG), Polypropylene Glycol (PPG), Polyethylene Glycol (PEO), Polyethylene Glycol (PEG), Copper, Iron, Tin, Organic Silicones, Zinc

Living Building Challenge Criteria:
 1. LBC Temp Exception RE-003 - Small Electrical Components
 2. LBC Red List Free
 3. LBC Red List Approved
 4. LBC Red List Not Applicable
 5. LBC Red List Not Applicable
 6. LBC Red List Not Applicable
 7. LBC Red List Not Applicable
 8. LBC Red List Not Applicable
 9. LBC Red List Not Applicable
 10. LBC Red List Not Applicable
 11. LBC Red List Not Applicable
 12. LBC Red List Not Applicable
 13. LBC Red List Not Applicable
 14. LBC Red List Not Applicable
 15. LBC Red List Not Applicable
 16. LBC Red List Not Applicable
 17. LBC Red List Not Applicable
 18. LBC Red List Not Applicable
 19. LBC Red List Not Applicable
 20. LBC Red List Not Applicable
 21. LBC Red List Not Applicable
 22. LBC Red List Not Applicable
 23. LBC Red List Not Applicable
 24. LBC Red List Not Applicable
 25. LBC Red List Not Applicable
 26. LBC Red List Not Applicable
 27. LBC Red List Not Applicable
 28. LBC Red List Not Applicable
 29. LBC Red List Not Applicable
 30. LBC Red List Not Applicable
 31. LBC Red List Not Applicable
 32. LBC Red List Not Applicable
 33. LBC Red List Not Applicable
 34. LBC Red List Not Applicable
 35. LBC Red List Not Applicable
 36. LBC Red List Not Applicable
 37. LBC Red List Not Applicable
 38. LBC Red List Not Applicable
 39. LBC Red List Not Applicable
 40. LBC Red List Not Applicable
 41. LBC Red List Not Applicable
 42. LBC Red List Not Applicable
 43. LBC Red List Not Applicable
 44. LBC Red List Not Applicable
 45. LBC Red List Not Applicable
 46. LBC Red List Not Applicable
 47. LBC Red List Not Applicable
 48. LBC Red List Not Applicable
 49. LBC Red List Not Applicable
 50. LBC Red List Not Applicable
 51. LBC Red List Not Applicable
 52. LBC Red List Not Applicable
 53. LBC Red List Not Applicable
 54. LBC Red List Not Applicable
 55. LBC Red List Not Applicable
 56. LBC Red List Not Applicable
 57. LBC Red List Not Applicable
 58. LBC Red List Not Applicable
 59. LBC Red List Not Applicable
 60. LBC Red List Not Applicable
 61. LBC Red List Not Applicable
 62. LBC Red List Not Applicable
 63. LBC Red List Not Applicable
 64. LBC Red List Not Applicable
 65. LBC Red List Not Applicable
 66. LBC Red List Not Applicable
 67. LBC Red List Not Applicable
 68. LBC Red List Not Applicable
 69. LBC Red List Not Applicable
 70. LBC Red List Not Applicable
 71. LBC Red List Not Applicable
 72. LBC Red List Not Applicable
 73. LBC Red List Not Applicable
 74. LBC Red List Not Applicable
 75. LBC Red List Not Applicable
 76. LBC Red List Not Applicable
 77. LBC Red List Not Applicable
 78. LBC Red List Not Applicable
 79. LBC Red List Not Applicable
 80. LBC Red List Not Applicable
 81. LBC Red List Not Applicable
 82. LBC Red List Not Applicable
 83. LBC Red List Not Applicable
 84. LBC Red List Not Applicable
 85. LBC Red List Not Applicable
 86. LBC Red List Not Applicable
 87. LBC Red List Not Applicable
 88. LBC Red List Not Applicable
 89. LBC Red List Not Applicable
 90. LBC Red List Not Applicable
 91. LBC Red List Not Applicable
 92. LBC Red List Not Applicable
 93. LBC Red List Not Applicable
 94. LBC Red List Not Applicable
 95. LBC Red List Not Applicable
 96. LBC Red List Not Applicable
 97. LBC Red List Not Applicable
 98. LBC Red List Not Applicable
 99. LBC Red List Not Applicable
 100. LBC Red List Not Applicable

XAL-0002
E031 03 MAR 2024
Original Issue Date: 2023

INTERNATIONAL LIVING FUTURE ASSOCIATION - <http://www.livingfuture.org>

BASO mounting instructions

Get access to the BASO 1.5 mounting instructions faster by scanning the QR code.

www.xalusa.com/resources/mounting-instructions/baso

